

Manitex

Manitex



M300

30-ton (27,2 mt) ROUGH TERRAIN CRANE
PRODUCT GUIDE

M300

30-ton (27,2 mt) ROUGH TERRAIN CRANE
PRODUCT GUIDE

UPTIME

UPTIME is the Manitex commitment to complete support of thousands of units working every day.







MANITEX
3000 South Austin Avenue
Georgetown, Texas 78626
1-877-314-3390 | www.Manitex.com

CONTENTS

Crane Features	4
Boom Diagram	5
Crane Weights	5
Load Chart: Main Boom	6
Area of Operation	7
Reeving Diagram	7
Crane Dimensions	8
Outrigger Extension	8
Technical Descriptions	9-10
Options	11
Notes	11

Effective Date: February 17, 2014
 This document is non-contractual. This document is supplied for reference use only. We are constantly making improvements to our products and reserve the right that specification, equipment, and prices are all subject to change without notice or obligation.
 The photographs, and /or images in this document are for illustrative purposes only and may include optional equipment and accessories and may not include all standard equipment.
 Refer to the appropriate Operator's Manual and Load Charts for instructions on the proper use of this equipment to determine allowable crane lifting capacities, assembly and operating procedures.
 Failure to follow the appropriate operator's manual or load chart(s) when using our equipment or to otherwise act irresponsibly may result in serious injury or death.
 The only warranty applicable to our equipment is the standard written warranty applicable to the particular product and sale. Manitex makes no other warranty, expressed or implied.
 Products and services listed may be trademarks, service marks or trade-names of Manitex International and /or its subsidiaries in the USA and other countries.
 All rights are reserved. Manitex® is a registered trademark of Manitex International, Inc. in the USA and many other countries.
 Copyright 2013 Manitex Inc. Manitex Inc, Georgetown Texas, 78626

OPTIONS

Options	
Jib	
	1-section 20 ft. (9,5 m) swing-away side-stowed jib with super small jib head
Hoist, Rope and Hook	
	30 Ton (26,8 m) 3-sheave hook block for 1-6 part line
	35 Ton (31,5 mt) 3-sheave hook block for 1-6 part line, Easy Reeve®
	7 Ton (6,4 mt) overhaul ball
Hydraulics	
	Tool ports and hose reel
Cab	
	LED work lights LED perimeter night light package (8 each) Strobe light Rear view camera Front windshield guard Cab vandal and protection screen (all window) Safety railings Slow moving vehicle emblem Manual boom angle
Cab	
	Auxiliary winch with 230 ft. (70,1 m) cable and rooster head - Includes (1) 7 Ton (6,4 mt) overhaul ball
	Recovery winch - Front mounted only

NOTES

- Picking loads above operator's compartment is not recommended
- Boom angles are undeflected boom angle
- All specifications are subject to change
- Loads above the blue line are based on structural competence
- Loads below the blue line are based on tipping

1. All operators and support personnel shall read and fully understand manufacturer furnished operator's manual, latest applicable American National Standards Institute (ANSI) Safety Standards for Cranes, and any applicable federal, state, or local safety regulations before operating machine. Crane and load ratings comply with ANSI and Power Crane & Shovel Association (PCSA) Standards.
2. All "ON OUTRIGGER" lifts shall be made with outrigger arms fully extended to fully support and level machine (tires off supporting surface). Additional structural blocking or cribbing may be required for some applications.
3. All ratings below the heavy blue line are based on 85% of tipping load "ON OUTRIGGERS" and 75% of tipping "ON TIRES" with machine stable on firm level ground. Ratings above the heavy blue line are based on structural competence. Boom angles are undeflected boom angles.
4. DO NOT EXCEED crane load ratings. When load radius or boom angle are between listed values, use the smaller load rating. DO NOT ATTEMPT TO TIP MACHINE TO DETERMINE ALLOWABLE LOADS.
5. Weights of hook blocks, bucket, slings, and all other load handling devices are not accounted for in the load chart. The load handling devices must be considered as part of the load.
6. Reduce ratings appropriately for wind conditions, speed of operation, soft or uneven supporting surfaces, etc.



CAUTION - IN WIND OVER 30 MPH, CEASE OPERATION; POSITION BOOM AWAY FROM WIND AND LOWER BOOM BELOW 60°.

IN WIND OVER 50 MPH, FULLY RETRACT AND LOWER BOOM TO LOWEST POSSIBLE POSITION.





7. Load ratings apply to this machine only as originally manufactured and equipped. Unauthorized modification or optional equipment may reduce load capacity. Please consult Manitex International Cranes BEFORE modification or use of optional equipment not covered in this chart.
8. DO NOT lift over operator cab.
9. WARNING - These load ratings are for lift service only.























TECHNICAL DESCRIPTIONS





















Control System	
	<p>Armrest mounted dual axis electro-proportional joysticks</p> <p>Steering wheel column with gear selector on the right and directional light selector on the left</p> <p>Dashboard mounted switches for outrigger operation</p>
Cab	
	<p>Fully enclosed one (1) person high visibility pressurized cab</p> <p>Standard features:</p> <ul style="list-style-type: none"> • Rubber floor mat • Tinted safety glass and mirrors • Six way adjustable seat • Heater/Defroster (1,200 BTU hot water) • Air conditioner • Window wiper with washer and top window • Two lockable doors with sliding windows <p>Control Panel includes:</p> <p>Fuel level, tachometer, speedometer, 6.5 LCD CANbus display, engine oil pressure, hydraulic oil pressure, temp. and level, engine water temp. and level, torque converter oil temp.</p>
Engine	
	<p>Cummins® QSB 6.7 Tier 3, 6 cylinders</p> <p>Rated power: 160 hp (119 kW) @ 2,500 rpm</p> <p>Intake: Turbocharger with intercooler</p> <p>Fuel type: Diesel</p> <p>Fuel tank capacity: 75 gal. (284 L)</p>



Drive-line	
	<p>6 x 6 powershift transmission with integral torque converter</p> <ul style="list-style-type: none"> • 3 forward speeds, high range • 3 forward speeds, low range • Rear axle disconnect <p>Auto centering axles</p>
Steering	
	<p>Hydraulic four wheel power steering with tilt steering column</p> <p>Four steering modes:</p> <ul style="list-style-type: none"> • 2 wheel front • 2 wheel rear • 2 wheel coordinated • 2 wheel crab <p>Front: Rigid, front planetary type steer axle</p> <p>Rear: Oscillating rear planetary steer axle</p> <p>Suspension: Oscillation with hydraulic lockout device</p> <p>Synchronized auto centering</p>
Tires	
	<p>16.00 x 25-32PR (L3)</p>
Electrical System	
	<p>24 volt electrical system</p> <p>State-of-the-art, weather-resistant components throughout</p> <p>Hermetically sealed enclosure includes power in relays and circuit status LEDs</p>

KEY

	Engine
	Steering
	Gross vehicle weight
	Weight on rear axle
	Standard (without hook block)
	Operator aids
	Cab
	Electrical system
	Controls
	Hoist speed
	1 - Main hoist 2 - Auxiliary winch 3 - Recovery winch
	Rope length
	Rope - standard/optional
	Rope diameter
	Maximum line pull
	Slewing / Allowable slewing range
	Slewing gears
	Slewing brake
	Outriggers / Lifting on outriggers
	Counterweight

	Mechanical transmission
	Tires
	Maximum speed
	Hydraulics
	Weight on front axle
	Swing on jib
	Lifting on wheels / Pick & Carry
	Maximum gradeability
	Hook block
	Distance from hook to head sheave pin
	Hook and ball
	Boom elevation angle
	Max. boom length with extension
	Boom with extension retracted
	Working radius
	Boom length
	Hydraulic actuated boom
	Full power mechanical synchronized
	Boom head / Hook block dimension
	Tip height



THE M300 ROUGH TERRAIN CRANE

Big job? Small space? No problem!

The cab-down M300 is just over 11 ft. tall, which makes it an ideal choice when space is limited. But don't be fooled by its compact size. This low-profile crane is designed for high performance. It offers:

- 4-wheel drive and 4-wheel steering so it maneuvers effortlessly - even in very tight spots
- Multiple boom configurations
- Highly visible, ergonomically engineered two-door cab with joystick controls
- Integrated features such as steps and handrails

Other features include:

- 30-ton capacity, 10 ft. rated distance from center of rotation
- Max. boom length: 77 ft.
- Max. boom tip height: 90 ft.
- Fully hydraulic disc brakes on all 4 wheels
- Full Load Moment Indicator and anti-two block system

LIFT CONFIDENTLY

In a pick and carry, there's no room for unpredictability. The M300's joystick controls are easy to use and responsive, so you're always in command.

SEE CLEARLY

With its low profile, sliding glass door and expansive use of glass, you'll never lose sight of your load. The two-door cab offers maximum space for maximum comfort.

GET IN AND OUT EASILY

Stop climbing over tires to reach the cab. With the M300, front-mounted steps and cab-mounted handrails make getting in and out easy.



TECHNICAL DESCRIPTIONS

Boom



Boom length: 3-section 77 ft. (23,5 m) proportional boom



Boom max. tip height: 90 ft. (27,4 m)



Boom angle (min/max): 0° / 71°

Rotation



Planetary reducer
Hydraulic motor



Slewing brake: Spring-applied hydraulic released brake
360° house lock - hydraulically applied



Boom rotation: 360° continuous
Slewing speed: 0 - 3 rpm

Outriggers



Outriggers: Hydraulic, independent extension, cantilever style

Outrigger pad size: 16 in. x 16 in. (406 mm x 406 mm)

Area of outrigger pads: 256 in.² (1,652 cm²)

Counterweight



Counterweight: 9,000 lbs. (4,082 kg)

Operator Aids



Graphic interface for load indicator
LMI Load Moment Indicator (w/cutouts)
Anti Two-block Device

Hoist, Rope and Hook



Maximum line speed:
High speed

- 404 fpm (123,1 mpm)

Low speed

- 248 fpm (75,6 mpm)

See page 6 for layer capacity and lift speed



Maximum line pull: 1st layer low-range:
12,510 lbs. (5,674 kg)

Maximum line pull permissible:
9,000 lbs. (4,082 kg)



Main winch cable diameter: 0.625 in. (14,3 mm)



Line length: 433 ft. (132 m)



6 x 19 IWRC XIPS, right regular lay, preformed



Main winch: Bent axis 2-speed hydraulic motor (activated electrically)

Grooved storage capacity: 611 ft. (186,2 m)



7T hook and ball: 232 lbs. (105 kg)

Hydraulics



Hydraulic pump: 3 variable piston pumps
Hydraulic oil reserve capacity: 110 gal. (416.4 L)
Hydraulic oil suction filter: 850 microns with magnet
Hydraulic oil return filter: 10 microns

Maximum Speed



Maximum speed (6th gear):
• Cummins® engine 25 mph (40 kph)

CRANE DIMENSIONS

Imperial & Metric Units

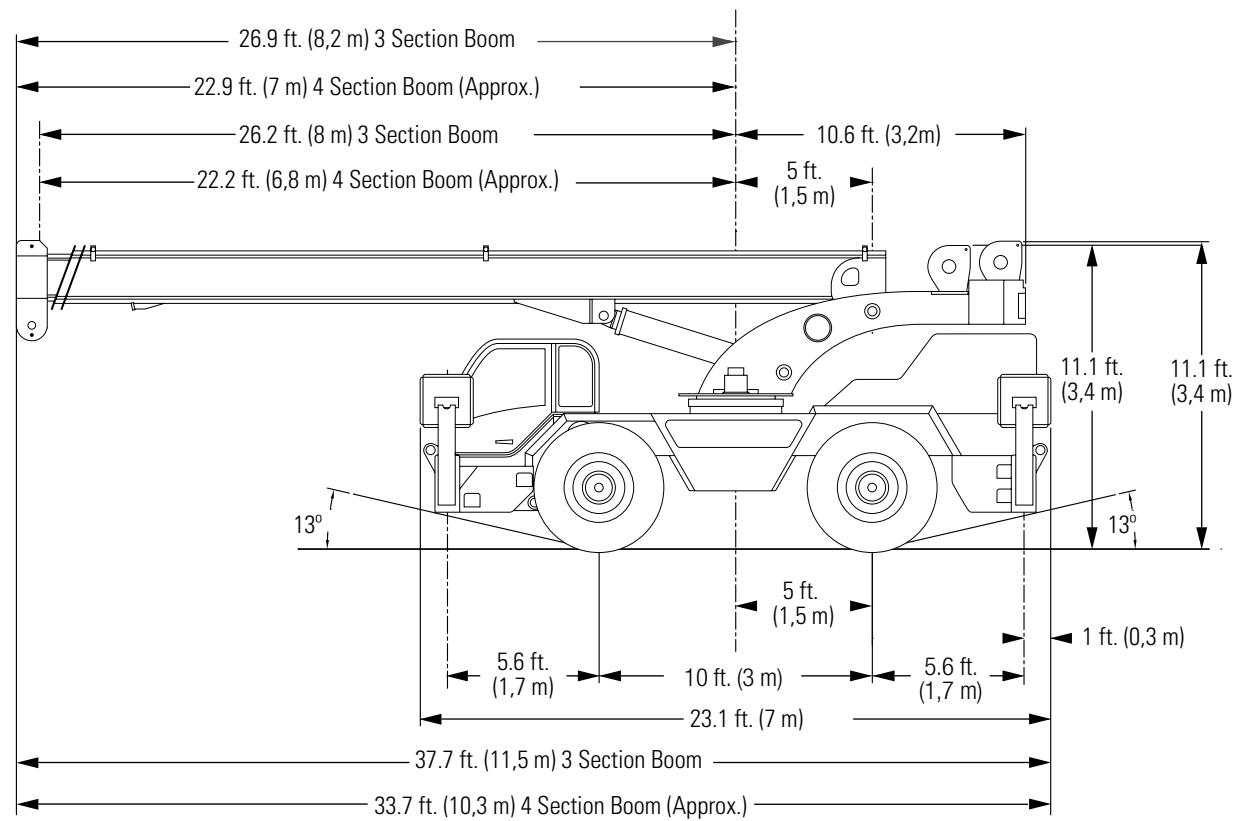

OUTRIGGER EXTENSION

Imperial & Metric Units

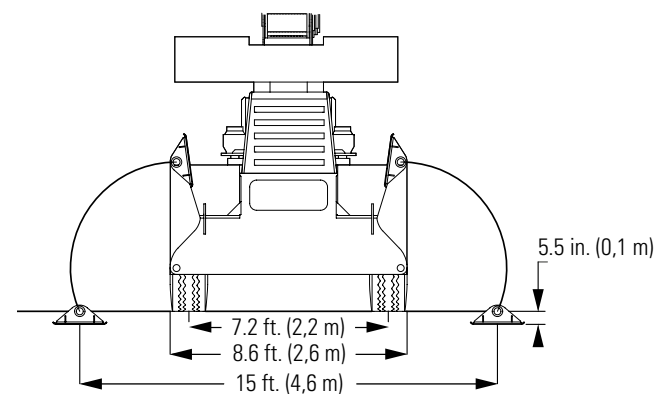

NOTE:

Tire Size:	14.00 x 24	17 x 25
Track width:	6 ft. 9 in. (2,1 m)	6 ft. 9 in. (2,1 m)
Overall width:	7 ft. 11.8 in. (2,4 m)	8 ft. 4.9 in. (2,6 m)

Notes: Additional axles required for federal bridge legal configuration - consult Manitex.
Manitex highly recommends the addition of a front stabilizer and it may be required on some installations - consult Manitex.

BOOM DIAGRAM

Imperial & Metric Units

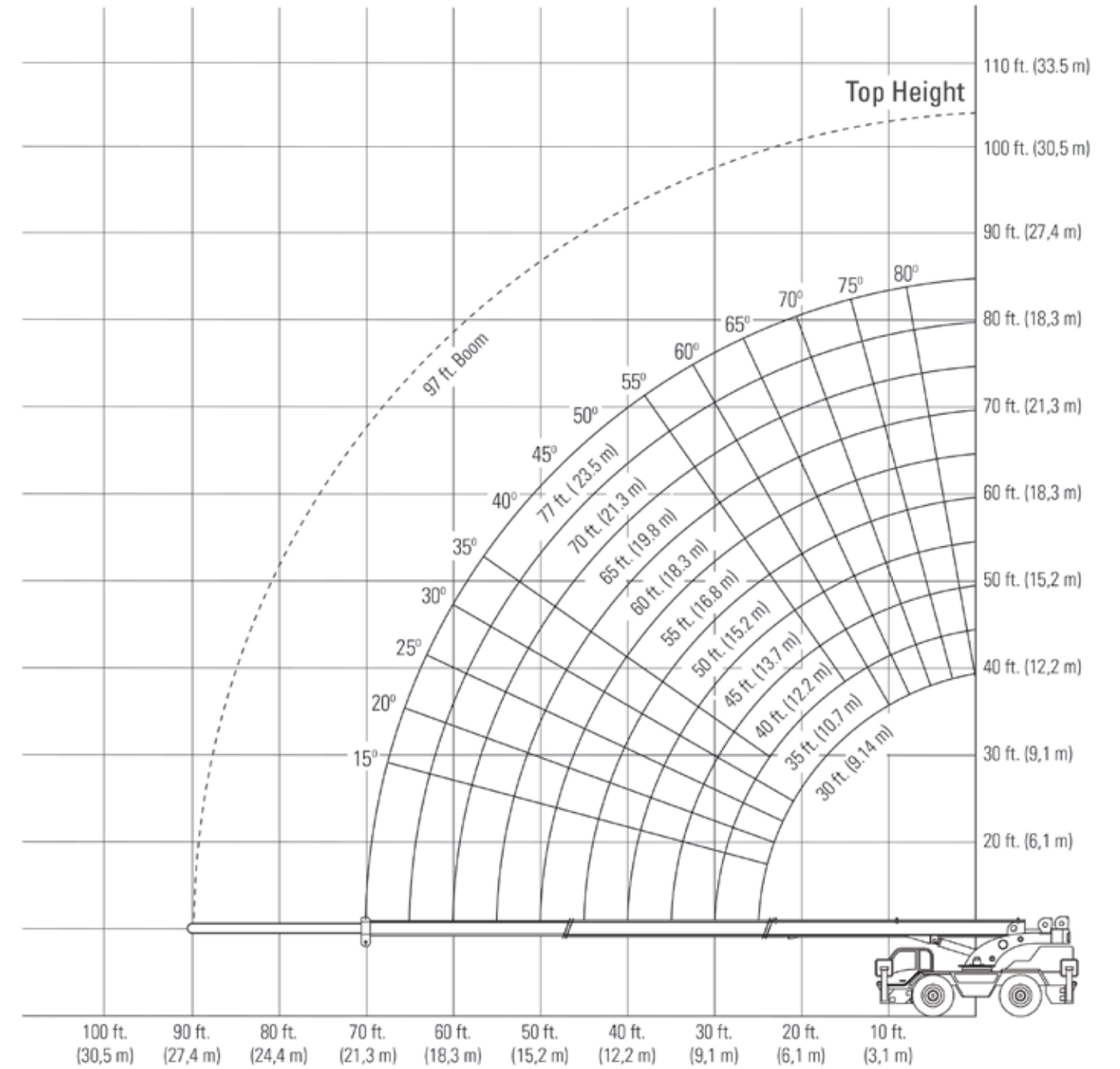

CRANE WEIGHTS

M300

54,750 lbs. (24,834 kg)

Data published herein is intended as a guide only. Crane operation is subject to the computer charts and operation manual supplied with the crane.

M300 LOAD CHART: Main Boom - On Outriggers

Lifting Capacities 3 Section Boom 31 ft. - 77 ft.
Imperial Units

9,000 lbs. 15 ft. (100%) 360° Continuous

Boom Angle (deg.)	31 ft. Boom			40 ft. Boom			50 ft. Boom			60 ft. Boom			70 ft. Boom			77 ft. Boom		
	Boom Angle (deg.)	Over Front (lbs.)	360° (lbs.)	Boom Angle (deg.)	Over Front (lbs.)	360° (lbs.)	Boom Angle (deg.)	Over Front (lbs.)	360° (lbs.)	Boom Angle (deg.)	Over Front (lbs.)	360° (lbs.)	Boom Angle (deg.)	Over Front (lbs.)	360° (lbs.)	Boom Angle (deg.)	Over Front (lbs.)	360° (lbs.)
10 ft.	61°	60,000	60,000	68°	55,000	55,000												
12 ft.	56°	50,000	50,000	65°	50,000	50,000	70°	45,000	45,000									
15 ft.	49°	40,000	40,000	60°	40,000	40,000	66°	37,500	37,500	71°	35,000	35,000						
20 ft.	35°	30,000	25,500	51°	30,000	25,500	60°	29,000	25,500	65°	28,000	25,500	69°	28,000	25,500			
25 ft.	10°	24,000	17,000	41°	24,000	17,000	53°	24,000	17,000	60°	24,000	17,000	65°	22,000	17,000	67°	20,000	17,000
30 ft.				29°	20,000	14,000	46°	18,000	14,000	54°	17,000	14,000	60°	16,500	14,000	63°	16,500	14,000
35 ft.				0°	17,100	10,600	37°	17,000	10,600	48°	16,500	10,600	55°	15,700	10,600	59°	15,000	10,600
40 ft.							26°	11,900	8,500	41°	11,900	8,500	50°	11,900	8,500	54°	11,900	8,500
45 ft.							0°	9,300	6,800	34°	9,300	6,800	44°	9,300	6,800	49°	9,300	6,800
50 ft.										24°	8,000	5,500	38°	8,000	5,500	44°	8,000	5,500
55 ft.										0°	6,800	4,650	31°	6,800	4,750	39°	6,800	4,750
60 ft.													22°	5,950	4,000	32°	5,950	4,000
65 ft.													0°	5,650	3,400	24°	5,650	3,400
70 ft.																12°	5,400	2,950

ON TIRES*

Max. Boom Length (ft.)	360° (lbs.)	Pick and Carry		Straight Over Front (lbs.)
		Stationary	Creep	
10 ft.	31	18,000	25,000	21,000
12 ft.	31	13,700	22,000	18,000
15 ft.	40	10,100	17,500	15,000
20 ft.	40	7,000	13,000	11,000
25 ft.	45	5,000	9,000	8,000
30 ft.	45	3,000	7,000	6,000
35 ft.	45	2,000	6,000	5,000
40 ft.	53	1,500	5,000	4,000
45 ft.	60		3,500	3,500
50 ft.	65		3,000	3,000
55 ft.	70		2,000	2,000
60 ft.	70		1,400	1,400
65 ft.	75		1,000	

*Tires (16 x 25-32 PR L3-Lugs)

20 ft. Jib on Outriggers		
Boom Angle (deg.)	Boom Radius (ref. ft.)	360° (lbs.)
70°	25	14,100
67°	30	12,900
63°	35	11,850
60°	40	10,600
57°	45	8,750
53°	50	7,350
49°	55	6,250
46°	60	5,350
41°	65	4,600
37°	70	4,000
32°	75	3,450
27°	80	3,000
20°	85	2,600
10°	90	2,250

NOTES:

- Loads above heavy line are based on structural rating
- Loads below heavy line are based on tipping rating
- Lifting with jib on tires is not permitted
- All "On Tires" tipping loads are based on 75% tipping
- Rotation of erect jib is allowed with boom fully retracted, creep only
- Transport of erect jib is allowed with boom fully retracted, 5 mph max
- Boom angles are undeflected boom angles
- These load ratings are for lift service only
- Pick & Carry permissible only with boom and loa centered over front
- Weight of hook blocks and slings is part of the load, and is to be deducted from the capacity ratings. Consult operation manual for further details

(Continued on pg. 11)

Tire Pressure

Tire Size	Stationary	Creep	2.5 MPG	Travel
16 x 25-32 PR	125 PSI	125 PSI	125 PSI	95 PSI

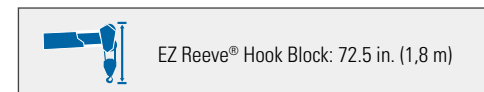

Data published herein is intended as a guide only. Crane operation is subject to the computer charts and operation manual supplied with the crane.

AREA OF OPERATION

On Outriggers

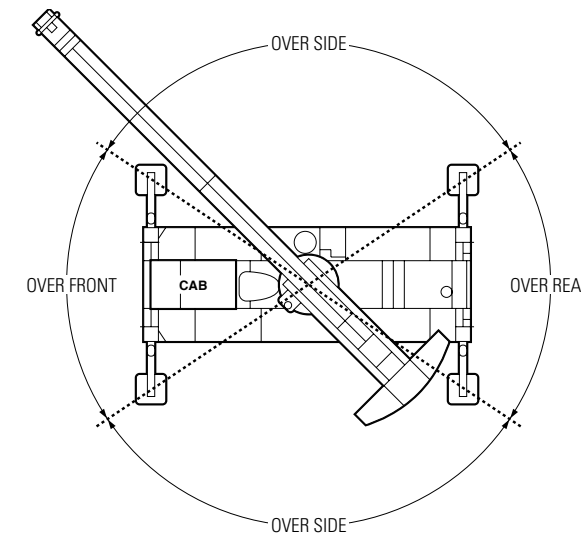

On Tires

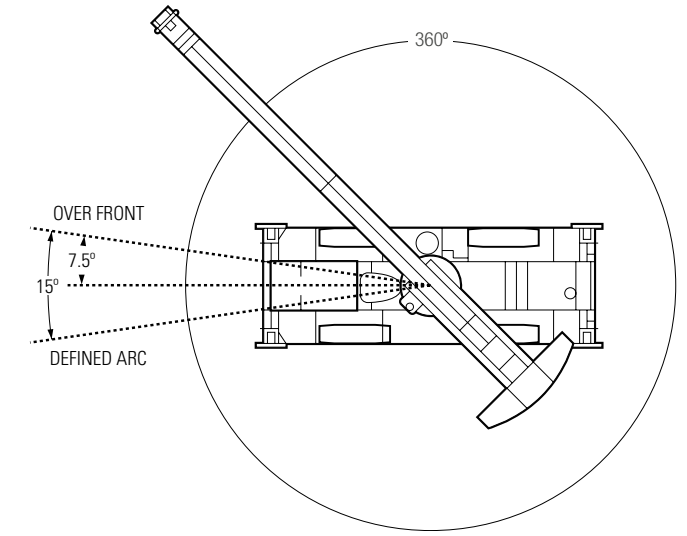

REEVING DIAGRAM

1 Part Line	2 Part Line	3 Part Line	4 Part Line	5 Part Line	6 Part Line	WARNING
						<ul style="list-style-type: none"> • Anti-two block system must be in good operating condition before operating crane. • Refer to the owner's manual. • Keep at least 3 wraps of load line on the drum at all times.
10,000 lbs.	20,000 lbs.	30,000 lbs.	40,000 lbs.	50,000 lbs.	60,000 lbs.	

Deductions from rated loads for load handling devices supplied by Manitex

Hook & ball	232 lbs. (105 kg)
20 ft. (9.5 m) Stowed Jib	400 lbs. (181 kg)
20 ft. (9.5 m) Erect Jib	1,000 lbs. (454 kg)

WARNING: Lifting off the main boom point while the jib is erected is not intended or approved.

Data published herein is intended as a guide only. Crane operation is subject to the computer charts and operation manual supplied with the crane.